

EMERGENCY SWITCHES

EMERGENCY SWITCHES



TECHNICAL SHEET

EMERGENCY SWITCHES

DUS-COV: DUST COVER



TEX-TI: TEXTURED TIPS



ENC-COV: ENCLOSED COVER



EMERGENCY SWITCHES



EMERGENCY SWITCHES

TECHNICAL SHEET

SI-PO: SIDE OF POLARITY

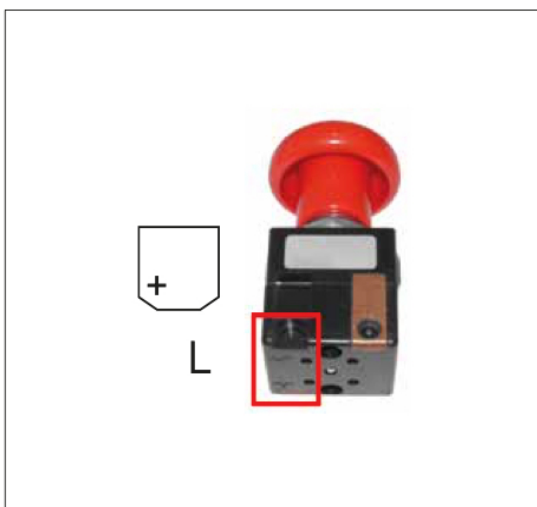
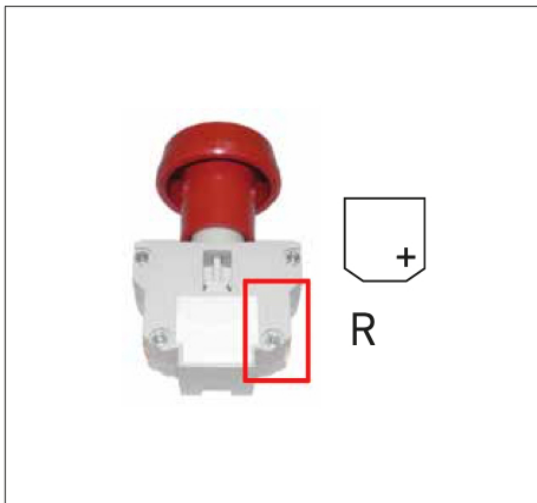
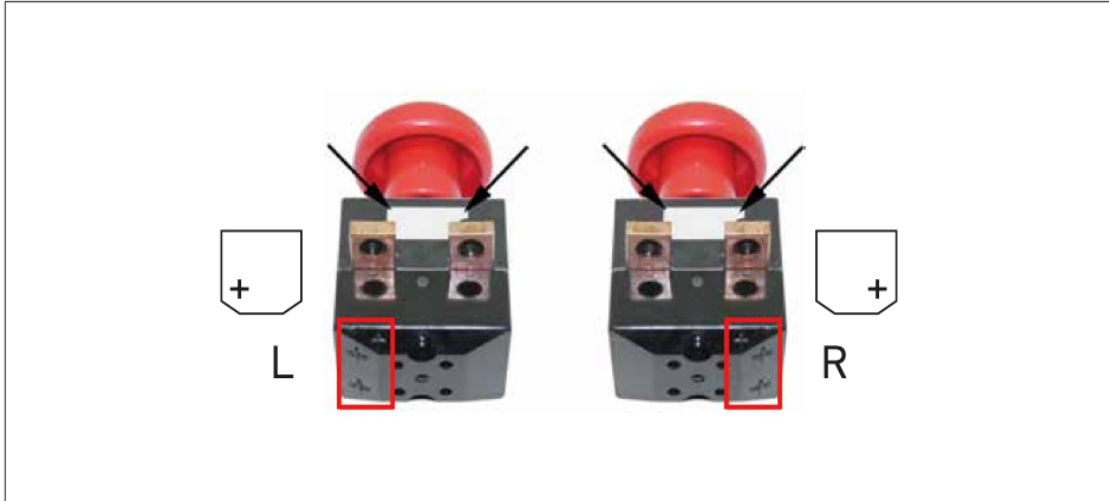

EMERGENCY SWITCHES



TECHNICAL SHEET

DIMENSIONS

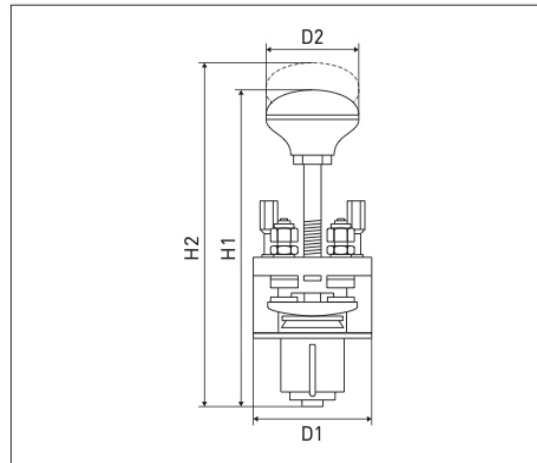
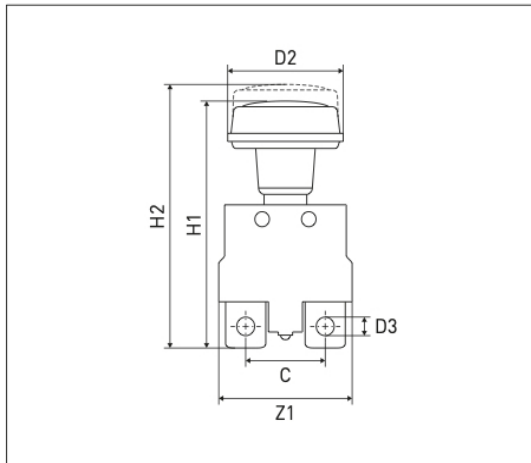
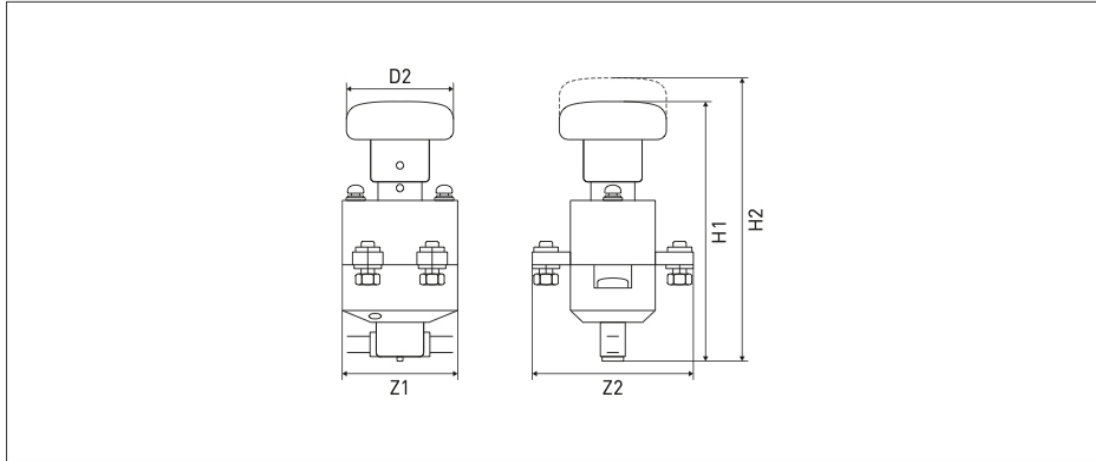

EMERGENCY SWITCHES

TVH PARTS NV
 Brabantstraat 15 · 8790 Waregem · Belgium
 T +32 56 43 42 11 · F +32 56 43 44 88 · info@tvh.com · www.tvh.com
 BTW BE 0425 399 042 · RLP Gent – division Kortrijk 0425 399 042
 BNP Paribas Fortis 285-0448248-40 · IBAN BE02 2850 4482 4840 · SWIFT/BIC GEBABEBB

EMERGENCY SWITCHES



EMERGENCY SWITCHES

TECHNICAL SHEET



TECHNISCHE FICHE

NOODSTOPSCHAKELAAR HOOG VERMOGEN

Groep
02-03-02-00

Voorbeeld

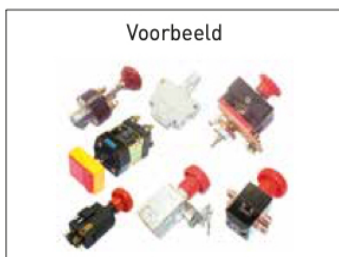

Gegevens klant

Type machine:

Prijsaanvraag

Serienr. machine:

Bestelling

- | | | |
|---------|-------|---|
| BRAND | | Merk van de schakelaar |
| TYPE | | Type van de schakelaar |
| I | | Elektrische stroom (ampère) |
| U | | Hoogste spanning (volt) |
| KN | | Knop aanwezig (ja/nee) |
| EX-CO | | Hulpcontact aanwezig (ja/nee) |
| BL-OU | | Blaasmagneten aanwezig (ja/nee). Indien JA, polariteit (SI-PO) invullen |
| LO-KE | | Vergrendelbaar met sleutel (ja/nee) |
| Z1 | | Maximale lengte van de voorzijde |
| Z2 | | Maximale lengte van de zijkant |
| D1 | | Diameter van de schakelaar, indien rond |
| H1 | | Totale hoogte in OFF-stand |
| H2 | | Totale hoogte in ON-stand |
| D2 | | Diameter van de knop, indien rond |
| Z3 | | Grootste lengte van de knop, indien rechthoekig |
| Z4 | | Kleinste lengte van de knop, indien rechthoekig |
| QTY-CO | | Totaal aantal aansluitingen |
| D3 | | Diameter van de aansluitingsgaten |
| C | | Centerafstand van de aansluitingsgaten |
| TY-SW | | Configuratie van de contacten:
<i>SP = enkelpolig</i>
<i>DP = dubbelpolig</i> |
| DUS-COV | | Stofplaat (ja/nee) |
| SI-PO | | Kant van polariteit:
<i>R = rechts</i>
<i>L = links</i> |
| | | Enkel van toepassing als blaasmagneten aanwezig zijn (anders 0 invullen).
Merklablel vooraan houden en dan ligging van de "+" bepalen (zie figuren). |
| TEX-TI | | Contact met textuur (ja/nee) |
| ENC-COV | | Afgesloten kap (ja/nee) |

EMERGENCY SWITCHES



TECHNICAL SHEET



FICHE TECHNIQUE

ARRET D'URGENCE HAUTE PUISSANCE

Groupe
02-03-02-00

Exemple

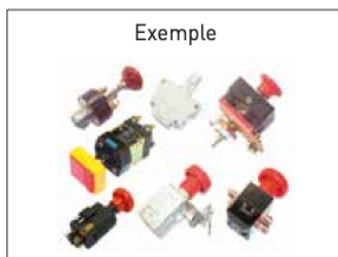

Données client

Type machine : Demande de prix
No. série machine : Commande

	BRAND	Marque de l'interrupteur
	TYPE	Type de l'interrupteur
	I	Ampérage
	U	Tension maximale (Volt)
	KN	Bouton présent (oui/non)
	EX-CO	Contact auxiliaire présent (oui/non)
	BL-OU	Aimant de soufflage présent (oui/non). Si OUI, indiquer côté de polarité (SI-PO)
	LO-KE	Vérouillable à clé (oui/non)
	Z1	Longueur maximale de la face avant
	Z2	Longueur maximale du côté
	D1	Diamètre de l'interrupteur, si rond
	H1	Hauteur totale en position OFF
	H2	Hauteur totale en position ON
	D2	Diamètre du bouton, si rond
	Z3	Plus grande longueur du bouton, si rectangle
	Z4	Plus petite longueur du bouton, si rectangle
	QTY-CO	Nombre de connexions
	D3	Diamètre des trous de connexion
	C	Entraxe des trous de connexion
	TY-SW	Configuration des contacts :
			<i>SP = unipolaire</i>
			<i>DP = bipolaire</i>
	DUS-COV	Plaque cache poussière (oui/non)
	SI-PO	Côté de polarité :
			<i>R = droit</i>
			<i>L = gauche</i>
			Doit être indiqué si le contacteur est muni d'aimants de soufflage (dans le cas contraire, remplir "0"). Tenir le contacteur avec l'étiquette portant la marque devant, puis définir la position du "+" (voir figures)
	TEX-TI	Pastilles de contacts texturées (oui/non)
	ENC-COV	Couvercle fermé (oui/non)

EMERGENCY SWITCHES

EMERGENCY SWITCHES



EMERGENCY SWITCHES

TECHNICAL SHEET



TECHNISCHES DATENBLATT

NOTSTOPSCHALTER HOHE LEISTUNG

Gruppe
02-03-02-00

Beispiel



Kundendaten

Maschinentyp:

Preis Anfrage

Serien-Nr. Maschine:

Bestellung

<input type="checkbox"/>	BRAND	Marke von dem Schalter
<input type="checkbox"/>	TYPE	Schaltertyp
<input type="checkbox"/>	I	Elektrischer Strom (Ampere)
<input type="checkbox"/>	U	Höchste Spannung (Volt)
<input type="checkbox"/>	KN	Knopf anwesend (ja/nein)
<input type="checkbox"/>	EX-CO	Hilfskontakte anwesend (ja/nein)
<input type="checkbox"/>	BL-OU	Blasmagneten anwesend (ja/nein). Wenn ja, bitte Polarität (SI-PO) angeben
<input type="checkbox"/>	LO-KE	Abschließbar mit Schlüssel (ja/nein)
<input type="checkbox"/>	Z1	Maximale Länge Vorderseite
<input type="checkbox"/>	Z2	Maximale Seitenlänge
<input type="checkbox"/>	D1	Durchmesser von dem Schalter, wenn rund
<input type="checkbox"/>	H1	Gesamthöhe im OFF-Stand
<input type="checkbox"/>	H2	Gesamthöhe im ON-Stand
<input type="checkbox"/>	D2	Knopfdurchmesser, wenn rund
<input type="checkbox"/>	Z3	Größte Knopflänge, wenn rechteckig
<input type="checkbox"/>	Z4	Kleinste Knopflänge, wenn rechteckig
<input type="checkbox"/>	QTY-CO	Gesamtanzahl Anschlüsse
<input type="checkbox"/>	D3	Durchmesser Anschlußlöcher
<input type="checkbox"/>	C	Lochabstand Anschlußlöcher
<input type="checkbox"/>	TY-SW	Polarität: SP = einpolig DP = doppeltepolig
<input type="checkbox"/>	DUS-COV	Staubplatte (ja/nein)
<input type="checkbox"/>	SI-PO	Seite Polarität: R = rechts L = links Nur verwendet wenn ein Blasmagnet anwesend ist (anders 0 ausfüllen) Markenetiket nach vorne halten und dann die Lage von dem "+" bestimmen (siehe Figur)
<input type="checkbox"/>	TEX-TI	Textured tips (ja/nein)
<input type="checkbox"/>	ENC-COV	Geschlossene Haube (ja/nein)

EMERGENCY SWITCHES



EMERGENCY SWITCHES











Used on: Albright							
ED80-10 Single-pole 	Current A	Max voltage V	Max length - front side - lateral side	Total height - in OFF pos - in ON pos	Remark	REF of complete switch	REF button
	80	48	59 mm 46 mm	123 mm 128 mm	2 connections.	165TA3565	107TA1103 
ED80-14 Single-pole 	Current A	Max voltage V	Max length - front side - lateral side	Total height - in OFF pos - in ON pos	Remark	REF of complete switch	REF button
	80	48	59 mm 46 mm	94 mm 100 mm	2 connections.	165TA3587	165TA3831
ED125 Single-pole 	Current A	Max voltage V	Max length - front side - lateral side	Total height - in OFF pos - in ON pos	Remark	REF of complete switch	REF button
	125	48	55 mm 43 mm	90 mm 96 mm	2 connections. Fitted with fixed contacts with M6 inserts.	139TA2590	116TA5222 
ED125 Single-pole 	Current A	Max voltage V	Max length - front side - lateral side	Total height - in OFF pos - in ON pos	Remark	REF of complete switch	REF button
	125	48	55 mm 43 mm	90 mm 96 mm	2 connections.	165TA3612	
ED125 Single-pole 	Current A	Max voltage V	Max length - front side - lateral side	Total height - in OFF pos - in ON pos	Remark	REF of complete switch	REF button
	125	48	55 mm 43 mm	90 mm 96 mm	2 connections. Fitted with fixed contacts with M8 inserts.	165TA3614	116TA5222 
ED125 Single-pole 	Current A	Max voltage V	Max length - front side - lateral side	Total height - in OFF pos - in ON pos	Remark	REF of complete switch	REF button
	125	48	55 mm 43 mm	90 mm 96 mm	2 connections. Longer operating shaft than REF 165TA3612.	139TA2588	116TA5222 
ED125 Single-pole 	Current A	Max voltage V	Max length - front side - lateral side	Total height - in OFF pos - in ON pos	Remark	REF of complete switch	REF button
	125	48	55 mm 43 mm	94 mm 100 mm	2 connections.	139TA2592	139TA2561 
ED125 Single-pole 	Current A	Max voltage V	Max length - front side - lateral side	Total height - in OFF pos - in ON pos	Remark	REF of complete switch	REF button
	125	48	55 mm 43 mm	100 mm 107 mm	2 connections. Lockable.	165TA3592	165TA3819 

EMERGENCY SWITCHES



EMERGENCY SWITCHES















Used on: Albright

ED125 Single-pole		Current A	Max voltage V	Max length - front side - lateral side	Total height - in OFF pos - in ON pos	Remark	REF of complete switch	REF button
		125	48	55 mm 43 mm	100 mm 107 mm	2 connections. Non-lockable.	107TA1102	165TA3819 
		125	48	55 mm 43 mm	100 mm 107 mm	2 connections. Non-lockable, with dust plate.	139TA2595	107TA1103 
		125	48	55 mm 43 mm	100 mm 107 mm	2 connections. Diameter connection: 7 mm.	165TA3621	165TA3819 
		125	48	55 mm 43 mm	105 mm 110 mm	2 connections.	165TA3588	139TA2561 
		125	48	55 mm 43 mm	117 mm 123 mm	4 connections.	165TA3628	116TA5222 
		125	48	55 mm 43 mm	122 mm 128 mm	6 connections.	165TA3542	165TA3819 
		125	48	55 mm 43 mm	130 mm 136 mm	6 connections.	165TA3615	165TA3819 
		125	96	55 mm 43 mm	102 mm 109 mm	2 connections.	165TA3543	165TA3820 

EMERGENCY SWITCHES



EMERGENCY SWITCHES















Used on: Albright							
ED150 Single-pole 	Current A	Max voltage V	Max length - front side - lateral side	Total height - in OFF pos - in ON pos	Remark	REF of complete switch	REF button
	150	48	50 mm 43 mm	101 mm 108 mm	2 connections.	165TA3551	165TA3819 
ED250 Single-pole 	Current A	Max voltage V	Max length - front side - lateral side	Total height - in OFF pos - in ON pos	Remark	REF of complete switch	REF button
	250	48	62 mm 55 mm	121 mm 132 mm	2 connections.	165TA3578	139TA2555 
ED250 Single-pole 	Current A	Max voltage V	Max length - front side - lateral side	Total height - in OFF pos - in ON pos	Remark	REF of complete switch	REF button
	250	48	62 mm 64 mm	114 mm 125 mm	2 connections. With dust plate, without textured contact tip, without enclosed cover.	165TA3601	165TA3819 
ED250 Single-pole 	Current A	Max voltage V	Max length - front side - lateral side	Total height - in OFF pos - in ON pos	Remark	REF of complete switch	REF button
	250	48	62 mm 64 mm	114 mm 125 mm	2 connections. Without dust plate, without textured contact tip, with enclosed cover.	165TA3538	107TA1103 
ED250 Single-pole 	Current A	Max voltage V	Max length - front side - lateral side	Total height - in OFF pos - in ON pos	Remark	REF of complete switch	REF button
	250	48	62 mm 64 mm	114 mm 125 mm	2 connections. Lockable with key.	107TA1100	165TA5003
ED250 Single-pole 	Current A	Max voltage V	Max length - front side - lateral side	Total height - in OFF pos - in ON pos	Remark	REF of complete switch	REF button
	250	48	62 mm 64 mm	114 mm 125 mm	2 connections. With enclosed cover.	165TA3582	165TA3819 
ED250 Single-pole 	Current A	Max voltage V	Max length - front side - lateral side	Total height - in OFF pos - in ON pos	Remark	REF of complete switch	REF button
	250	48	62 mm 64 mm	114 mm 125 mm	2 connections. Without dust plate, without textured contact tip, without enclosed cover.	139TA5973	107TA1103 
ED250 Single-pole 	Current A	Max voltage V	Max length - front side - lateral side	Total height - in OFF pos - in ON pos	Remark	REF of complete switch	REF button
	250	96	62 mm 55 mm	121 mm 132 mm	2 connections.	165TA3547	139TA2555 

EMERGENCY SWITCHES













EMERGENCY SWITCHES

Used on: **Albright**

ED250 Single-pole 	Current A	Max voltage V	Max length - front side - lateral side	Total height - in OFF pos - in ON pos	Remark	REF of complete switch	REF button
	250	96	62 mm 64 mm	114 mm 125 mm	2 connections. Without blowout magnets.	165TA3597	107TA1103 
ED250 Single-pole 	Current A	Max voltage V	Max length - front side - lateral side	Total height - in OFF pos - in ON pos	Remark	REF of complete switch	REF button
	250	96	62 mm 64 mm	114 mm 125 mm	2 connections. With blowout magnets on the right.	165TA3593	165TA3819 
ED250 Single-pole 	Current A	Max voltage V	Max length - front side - lateral side	Total height - in OFF pos - in ON pos	Remark	REF of complete switch	REF button
	250	96	62 mm 64 mm	114 mm 125 mm	2 connections. With blowout magnets on the left.	165TA3605	107TA1103 
ED250 Single-pole 	Current A	Max voltage V	Max length - front side - lateral side	Total height - in OFF pos - in ON pos	Remark	REF of complete switch	REF button
	250	96	62 mm 64 mm	125 mm 135 mm	2 connections.	165TA3567	107TA1103 
ED250 Single-pole 	Current A	Max voltage V	Max length - front side - lateral side	Total height - in OFF pos - in ON pos	Remark	REF of complete switch	REF button
	250	96	62 mm 101 mm	141 mm 152 mm	2 connections.	165TA3599	139TA2553 
ED250 Single-pole 	Current A	Max voltage V	Max length - front side - lateral side	Total height - in OFF pos - in ON pos	Remark	REF of complete switch	REF button
	250	96	63 mm 65 mm	111 mm 123 mm	2 connections.	165TA3560	165TA3819 
ED250 Single-pole 	Current A	Max voltage V	Max length - front side - lateral side	Total height - in OFF pos - in ON pos	Remark	REF of complete switch	REF button
	250	96	64 mm 64 mm	114 mm 123 mm	2 connections.	165TA3558	
ED250A Single-pole 	Current A	Max voltage V	Max length - front side - lateral side	Total height - in OFF pos - in ON pos	Remark	REF of complete switch	REF button
	250	48	62 mm 64 mm	135 mm 145 mm	6 connections. Different contact spring assembly (higher contact pressure) + different polarity.	165TA3549	165TA3819 

EMERGENCY SWITCHES











Used on: Albright							
ED250A Single-pole 	Current A	Max voltage V	Max length - front side - lateral side	Total height - in OFF pos - in ON pos	Remark	REF of complete switch	REF button
	250	48	62 mm 64 mm	135 mm 145 mm	6 connections. Different contact spring assembly + different polarity.	165TA3556	107TA1103 
ED250A Single-pole 	Current A	Max voltage V	Max length - front side - lateral side	Total height - in OFF pos - in ON pos	Remark	REF of complete switch	REF button
	250	96	62 mm 64 mm	111 mm 122 mm	6 connections.	165TA3619	165TA4728 
ED250A Single-pole 	Current A	Max voltage V	Max length - front side - lateral side	Total height - in OFF pos - in ON pos	Remark	REF of complete switch	REF button
	250	96	62 mm 64 mm	135 mm 145 mm	6 connections. Contacts are different from REF 165TA3606, without enclosed cover.	165TA3564	165TA3819 
ED250A Single-pole 	Current A	Max voltage V	Max length - front side - lateral side	Total height - in OFF pos - in ON pos	Remark	REF of complete switch	REF button
	250	96	62 mm 64 mm	135 mm 145 mm	6 connections. Contacts are different from REF 165TA3564, without enclosed cover.	165TA3606	107TA1103 
ED250A Single-pole 	Current A	Max voltage V	Max length - front side - lateral side	Total height - in OFF pos - in ON pos	Remark	REF of complete switch	REF button
	250	96	62 mm 64 mm	135 mm 145 mm	6 connections. With enclosed cover.	165TA3616	165TA3819 
ED252 Double-pole 	Current A	Max voltage V	Max length - front side - lateral side	Total height - in OFF pos - in ON pos	Remark	REF of complete switch	REF button
	250	96	62 mm 82 mm	114 mm 125 mm	4 connections. With key, switch type: ED252, without enclosed cover.	107TA1105	165TA5004
ED252 Double-pole 	Current A	Max voltage V	Max length - front side - lateral side	Total height - in OFF pos - in ON pos	Remark	REF of complete switch	REF button
	250	96	62 mm 82 mm	114 mm 125 mm	4 connections. Switch type: ED252, without enclosed cover, different spring than REF 115TA4626.	106TA1209	165TA3830
ED252 Double-pole 	Current A	Max voltage V	Max length - front side - lateral side	Total height - in OFF pos - in ON pos	Remark	REF of complete switch	REF button
	250	96	62 mm 82 mm	114 mm 125 mm	4 connections. Switch type: ED252, without enclosed cover, different spring than REF 106TA1209.	115TA4626	165TA3830

EMERGENCY SWITCHES

















EMERGENCY SWITCHES

Used on: Albright

ED252 Double-pole 	Current A	Max voltage V	Max length - front side - lateral side	Total height - in OFF pos - in ON pos	Remark	REF of complete switch	REF button
	250	150	62 mm 82 mm	114 mm 125 mm	4 connections.	165TA3583	165TA3830
ED252-4 Double-pole 	Current A	Max voltage V	Max length - front side - lateral side	Total height - in OFF pos - in ON pos	Remark	REF of complete switch	REF button
	250	96	62 mm 82 mm	114 mm 125 mm	4 connections.	165TA3589	107TA1103 
ED252A Double-pole 	Current A	Max voltage V	Max length - front side - lateral side	Total height - in OFF pos - in ON pos	Remark	REF of complete switch	REF button
	250	96	62 mm 82 mm	135 mm 145 mm	8 connections.	139TA2626	107TA1103 
ED252A Double-pole 	Current A	Max voltage V	Max length - front side - lateral side	Total height - in OFF pos - in ON pos	Remark	REF of complete switch	REF button
	250	150	62 mm 82 mm	135 mm 146 mm	8 connections.	165TA3571	107TA1103 
SD150A Single-pole 	Current A	Max voltage V	Max length - front side - lateral side	Total height - in OFF pos - in ON pos	Remark	REF of complete switch	REF button
	125	24	61 mm 50 mm	144 mm 151 mm	8 connections.	139TA2640	139TA2561 
SD150A Single-pole 	Current A	Max voltage V	Max length - front side - lateral side	Total height - in OFF pos - in ON pos	Remark	REF of complete switch	REF button
	125	24	61 mm 50 mm	149 mm 155 mm	6 connections.	165TA3604	165TA3821 
SD150A Single-pole 	Current A	Max voltage V	Max length - front side - lateral side	Total height - in OFF pos - in ON pos	Remark	REF of complete switch	REF button
	125	24	61 mm 50 mm	150 mm 155 mm	6 connections. Standard hardware kit.	139TA2635	165TA3821 
SD150A Single-pole 	Current A	Max voltage V	Max length - front side - lateral side	Total height - in OFF pos - in ON pos	Remark	REF of complete switch	REF button
	125	24	61 mm 50 mm	150 mm 155 mm	6 connections. Special hardware kit.	165TA3598	165TA3751 

EMERGENCY SWITCHES















Used on: Albright							
SD150A Single-pole 	Current	Max voltage	Max length	Total height	Remark	REF of complete switch	REF button
	A	V	- front side - lateral side	- in OFF pos - in ON pos			
	125	24	61 mm 50 mm	150 mm 155 mm	6 connections. Standard contact pressure.	165TA3613	107TA1103 
SD150A Single-pole 	Current	Max voltage	Max length	Total height	Remark	REF of complete switch	REF button
	A	V	- front side - lateral side	- in OFF pos - in ON pos			
	125	24	61 mm 50 mm	150 mm 155 mm	6 connections. Higher contact pressure (better contact performance).	112TA5000	107TA1103 
SD150A Single-pole 	Current	Max voltage	Max length	Total height	Remark	REF of complete switch	REF button
	A	V	- front side - lateral side	- in OFF pos - in ON pos			
	125	24	61 mm 50 mm	150 mm 155 mm	6 connections. Same switch as REF 112TA5000 but screws are 20 mm long instead of 16 mm.	165TA3631	107TA1103 
SD150A Single-pole 	Current	Max voltage	Max length	Total height	Remark	REF of complete switch	REF button
	A	V	- front side - lateral side	- in OFF pos - in ON pos			
	125	24	61 mm 50 mm	155 mm 161 mm	8 connections.	107TA1108	139TA2561 
SD150A Single-pole 	Current	Max voltage	Max length	Total height	Remark	REF of complete switch	REF button
	A	V	- front side - lateral side	- in OFF pos - in ON pos			
	125	24	61 mm 50 mm	164 mm 171 mm	8 connections.	165TA3607	165TA3821 
SD150A Single-pole 	Current	Max voltage	Max length	Total height	Remark	REF of complete switch	REF button
	A	V	- front side - lateral side	- in OFF pos - in ON pos			
	150	24	61 mm 50 mm	149 mm 155 mm	2 connections.	165TA3569	165TA3821 
SD150A-47 Single-pole 	Current	Max voltage	Max length	Total height	Remark	REF of complete switch	REF button
	A	V	- front side - lateral side	- in OFF pos - in ON pos			
	125	14	61 mm 50 mm	116 mm 116 mm	6 connections.	165TA3546	
SD200A Single-pole 	Current	Max voltage	Max length	Total height	Remark	REF of complete switch	REF button
	A	V	- front side - lateral side	- in OFF pos - in ON pos			
	200	24	59 mm 68 mm	145 mm 150 mm	8 connections.	165TA3600	107TA1103 

EMERGENCY SWITCHES

















EMERGENCY SWITCHES

Used on: Albright

SD200A Single-pole 	Current A	Max voltage V	Max length - front side - lateral side	Total height - in OFF pos - in ON pos	Remark	REF of complete switch	REF button
	200	24	59 mm 74 mm	145 mm 150 mm	8 connections. Pre-fitted operating knob.	165TA3579	165TA3823
SD200A Single-pole 	Current A	Max voltage V	Max length - front side - lateral side	Total height - in OFF pos - in ON pos	Remark	REF of complete switch	REF button
	200	24	59 mm 74 mm	145 mm 150 mm	8 connections. Operating knob comes separately with a hardware kit.	165TA3624	107TA1103 
SD200A Single-pole 	Current A	Max voltage V	Max length - front side - lateral side	Total height - in OFF pos - in ON pos	Remark	REF of complete switch	REF button
	200	24	59 mm 76 mm	163 mm 168 mm	11 connections.	165TA3557	165TA5002
SD200A Single-pole 	Current A	Max voltage V	Max length - front side - lateral side	Total height - in OFF pos - in ON pos	Remark	REF of complete switch	REF button
	200	24	59 mm 82 mm	163 mm 168 mm	11 connections.	165TA3544	107TA1103 
SD200A Single-pole 	Current A	Max voltage V	Max length - front side - lateral side	Total height - in OFF pos - in ON pos	Remark	REF of complete switch	REF button
	200	24	59 mm 94 mm	147 mm 151 mm	8 connections.	165TA3596	107TA1103 
SD250 Single-pole 	Current A	Max voltage V	Max length - front side - lateral side	Total height - in OFF pos - in ON pos	Remark	REF of complete switch	REF button
	250	24	62 mm 56 mm	168 mm 174 mm	4 connections.	139TA2647	139TA2555 
SD250-17 Single-pole 	Current A	Max voltage V	Max length - front side - lateral side	Total height - in OFF pos - in ON pos	Remark	REF of complete switch	REF button
	250	48	62 mm 56 mm	168 mm 174 mm	4 connections.	165TA3537	139TA2555 
SD250A Single-pole 	Current A	Max voltage V	Max length - front side - lateral side	Total height - in OFF pos - in ON pos	Remark	REF of complete switch	REF button
	250	24	62 mm 56 mm	136 mm 141 mm	6 connections. With textured contact tip.	165TA3555	

EMERGENCY SWITCHES









Used on: Albright							
SD250A Single-pole 	Current A	Max voltage V	Max length - front side - lateral side	Total height - in OFF pos - in ON pos	Remark	REF of complete switch	REF button
	250	24	62 mm 56 mm	136 mm 141 mm	6 connections. Without textured contact tips.	139TA2649	139TA2561 
SD250A Single-pole 	Current A	Max voltage V	Max length - front side - lateral side	Total height - in OFF pos - in ON pos	Remark	REF of complete switch	REF button
	250	24	62 mm 56 mm	147 mm 153 mm	6 connections.	165TA3625	139TA2561 
SD250A Single-pole 	Current A	Max voltage V	Max length - front side - lateral side	Total height - in OFF pos - in ON pos	Remark	REF of complete switch	REF button
	250	24	62 mm 56 mm	168 mm 174 mm	6 connections. CO-rated coil.	165TA3610	107TA1103 
SD250A Single-pole 	Current A	Max voltage V	Max length - front side - lateral side	Total height - in OFF pos - in ON pos	Remark	REF of complete switch	REF button
	250	24	62 mm 56 mm	168 mm 174 mm	6 connections. INT-rated coil.	115TA4627	107TA1103 
SD250A Single-pole 	Current A	Max voltage V	Max length - front side - lateral side	Total height - in OFF pos - in ON pos	Remark	REF of complete switch	REF button
	250	24	62 mm 56 mm	168 mm 174 mm	6 connections. With dust plate.	165TA3566	139TA2555 
SD250A Single-pole 	Current A	Max voltage V	Max length - front side - lateral side	Total height - in OFF pos - in ON pos	Remark	REF of complete switch	REF button
	250	48	62 mm 56 mm	136 mm 141 mm	6 connections.	165TA3629	
SD250A Single-pole 	Current A	Max voltage V	Max length - front side - lateral side	Total height - in OFF pos - in ON pos	Remark	REF of complete switch	REF button
	250	48	62 mm 56 mm	168 mm 174 mm	6 connections.	139TA2650	139TA2555 
SD250A Single-pole 	Current A	Max voltage V	Max length - front side - lateral side	Total height - in OFF pos - in ON pos	Remark	REF of complete switch	REF button
	250	80	62 mm 56 mm	168 mm 174 mm	6 connections.	165TA3545	139TA2555 

EMERGENCY SWITCHES



EMERGENCY SWITCHES

Used on: Albright

 SD250A Single-pole	Current	Max voltage	Max length	Total height	Remark	REF of complete switch	REF button
	A	V	- front side - lateral side	- in OFF pos - in ON pos			
	250	96	62 mm 56 mm	141 mm 152 mm	6 connections.	165TA3595	139TA2555 
 SD300A Single-pole	Current	Max voltage	Max length	Total height	Remark	REF of complete switch	REF button
	A	V	- front side - lateral side	- in OFF pos - in ON pos			
	300	24	61 mm 95 mm	172 mm 177 mm	11 connections.	165TA8451	111TA1103 
 SW155 Double-pole	Current	Max voltage	Max length	Total height	Remark	REF of complete switch	REF button
	A	V	- front side - lateral side	- in OFF pos - in ON pos			
	200	96		155 mm 160 mm	4 connections.	165TA3559	106TA1210 
 SW159 Single-pole	Current	Max voltage	Max length	Total height	Remark	REF of complete switch	REF button
	A	V	- front side - lateral side	- in OFF pos - in ON pos			
	200	48		156 mm 160 mm	2 connections.	106TA1207	139TA2554 
 SW203 Single-pole	Current	Max voltage	Max length	Total height	Remark	REF of complete switch	REF button
	A	V	- front side - lateral side	- in OFF pos - in ON pos			
	250	120	72 mm 56 mm	185 mm 190 mm	2 connections.	165TA3552	139TA2554 

EMERGENCY SWITCHES



EMERGENCY SWITCHES

Used on: **Elektrosistem**







BDS200 Single-pole 	Current	Max voltage	Max length	Total height	Remark	REF of complete switch	REF button
	A	V	- front side - lateral side	- in OFF pos - in ON pos			
	200		85 mm 49 mm	106 mm 116 mm	2 connections.	165TA8453	
BDS200 Single-pole 	Current	Max voltage	Max length	Total height	Remark	REF of complete switch	REF button
	A	V	- front side - lateral side	- in OFF pos - in ON pos			
	200		85 mm 49 mm	146 mm 158 mm	5 connections.	165TA8452	
BDS200 Single-pole 	Current	Max voltage	Max length	Total height	Remark	REF of complete switch	REF button
	A	V	- front side - lateral side	- in OFF pos - in ON pos			
	200		86 mm 49 mm	114 mm 124 mm	2 connections.	165TA8450	165TA3829
Single-pole 	Current	Max voltage	Max length	Total height	Remark	REF of complete switch	REF button
	A	V	- front side - lateral side	- in OFF pos - in ON pos			
	150	48	80 mm 34 mm	88 mm 95 mm	2 connections.	165TA3622	139TA2556 

EMERGENCY SWITCHES



EMERGENCY SWITCHES

Used on: **Hardellet**

Single-pole 	Current A	Max voltage V	Max length - front side - lateral side	Total height - in OFF pos - in ON pos	Remark 2 connections.	REF of complete switch 106TA1220	REF button 107TA1109 
	150	48	46 mm 42 mm	95 mm 100 mm			
Single-pole 	Current A	Max voltage V	Max length - front side - lateral side	Total height - in OFF pos - in ON pos	Remark 2 connections.	REF of complete switch 165TA3608	REF button 107TA1111 
	150	48	46 mm 42 mm	95 mm 101 mm			
Single-pole 	Current A	Max voltage V	Max length - front side - lateral side	Total height - in OFF pos - in ON pos	Remark 2 connections.	REF of complete switch 107TA1112	REF button 139TA2561 
	150	48	46 mm 42 mm	100 mm 105 mm			
Single-pole 	Current A	Max voltage V	Max length - front side - lateral side	Total height - in OFF pos - in ON pos	Remark 2 connections.	REF of complete switch 165TA3618	REF button 116TA5222 
	150	48	62 mm 46 mm	77 mm 85 mm			
Single-pole 	Current A	Max voltage V	Max length - front side - lateral side	Total height - in OFF pos - in ON pos	Remark 2 connections.	REF of complete switch 106TA1219	REF button 107TA1109 
	150	48	62 mm 46 mm	95 mm 100 mm			

EMERGENCY SWITCHES



Used on: Kissling

Used on: Kissling							
Series 24 Single-pole 	Current A	Max voltage V	Max length - front side - lateral side	Total height - in OFF pos - in ON pos	Remark	REF of complete switch	REF button
	100	80	65 mm 38 mm	113 mm 120 mm	2 connections. Diameter connection: 9 mm.	124TA1679	112TA5001 
Series 24 Single-pole 	Current A	Max voltage V	Max length - front side - lateral side	Total height - in OFF pos - in ON pos	Remark	REF of complete switch	REF button
	300	80	65 mm 38 mm	92 mm 92 mm	2 connections. Diameter connection: 9 mm.	139TA2684	165TA8455 
Series 24 Single-pole 	Current A	Max voltage V	Max length - front side - lateral side	Total height - in OFF pos - in ON pos	Remark	REF of complete switch	REF button
	300	80	65 mm 38 mm	112 mm 122 mm	2 connections. Diameter connection: 9 mm.	165TA8445	111TA3904 

EMERGENCY SWITCHES

EMERGENCY SWITCHES



EMERGENCY SWITCHES









Used on: Rema

190 Single-pole 	Current A	Max voltage V	Max length - front side - lateral side	Total height - in OFF pos - in ON pos	Remark	REF of complete switch	REF button
	190		70 mm 42 mm	136 mm 148 mm	4 connections.	111TA3902	139TA2564 
DIN80A Single-pole 	Current A	Max voltage V	Max length - front side - lateral side	Total height - in OFF pos - in ON pos	Remark	REF of complete switch	REF button
	125		72 mm 69 mm	122 mm 135 mm	2 connections.	107TA1127	139TA2564 
Single-pole 	Current A	Max voltage V	Max length - front side - lateral side	Total height - in OFF pos - in ON pos	Remark	REF of complete switch	REF button
	190		70 mm 42 mm	120 mm 132 mm	4 connections.	116TA5384	139TA2564 
Single-pole 	Current A	Max voltage V	Max length - front side - lateral side	Total height - in OFF pos - in ON pos	Remark	REF of complete switch	REF button
	300	48	75 mm 38 mm	103 mm 115 mm	2 connections.	165TA8447	139TA2559 
Single-pole 	Current A	Max voltage V	Max length - front side - lateral side	Total height - in OFF pos - in ON pos	Remark	REF of complete switch	REF button
	300		75 mm 38 mm	103 mm 115 mm	2 connections.	165TA8446	139TA2564 
Single-pole 	Current A	Max voltage V	Max length - front side - lateral side	Total height - in OFF pos - in ON pos	Remark	REF of complete switch	REF button
	300		75 mm 38 mm	110 mm 120 mm	2 connections.	139TA2695	139TA2564 
Single-pole 	Current A	Max voltage V	Max length - front side - lateral side	Total height - in OFF pos - in ON pos	Remark	REF of complete switch	REF button
	350	220	47 mm 75 mm	111 mm 124 mm	2 connections.	165TA3548	165TA5005 

EMERGENCY SWITCHES



EMERGENCY SWITCHES

Used on: Schaltbau							
C130/180 Single-pole 	Current A	Max voltage V	Max length - front side - lateral side	Total height - in OFF pos - in ON pos	Remark	REF of complete switch	REF button
	140	24	89 mm 75 mm	177 mm 184 mm	7 connections.	165TA3609	139TA2562 
C130/250 Single-pole 	Current A	Max voltage V	Max length - front side - lateral side	Total height - in OFF pos - in ON pos	Remark	REF of complete switch	REF button
	120	48	125 mm 88 mm	155 mm 163 mm	9 connections.	139TA2700	139TA2561 
S132 Single-pole 	Current A	Max voltage V	Max length - front side - lateral side	Total height - in OFF pos - in ON pos	Remark	REF of complete switch	REF button
	125	48	70 mm 32 mm	109 mm 121 mm	2 connections.	165TA3623	106TA1232 
S132 Single-pole 	Current A	Max voltage V	Max length - front side - lateral side	Total height - in OFF pos - in ON pos	Remark	REF of complete switch	REF button
	125	48	70 mm 32 mm	119 mm 131 mm	2 connections.	165TA3570	111TA3899 
S132 Single-pole 	Current A	Max voltage V	Max length - front side - lateral side	Total height - in OFF pos - in ON pos	Remark	REF of complete switch	REF button
	125		70 mm 32 mm	79 mm 91 mm	2 connections. With blowout magnets.	107TA1117	106TA1206 
S132 Single-pole 	Current A	Max voltage V	Max length - front side - lateral side	Total height - in OFF pos - in ON pos	Remark	REF of complete switch	REF button
	125		70 mm 32 mm	79 mm 91 mm	2 connections. Without blowout magnets.	107TA1118	139TA2564 
S132 Single-pole 	Current A	Max voltage V	Max length - front side - lateral side	Total height - in OFF pos - in ON pos	Remark	REF of complete switch	REF button
	125		70 mm 32 mm	111 mm 123 mm	2 connections.	139TA5972	139TA2561 
S134 Single-pole 	Current A	Max voltage V	Max length - front side - lateral side	Total height - in OFF pos - in ON pos	Remark	REF of complete switch	REF button
	250		70 mm 42 mm	95 mm 107 mm	2 connections.	106TA1233	139TA2561 

EMERGENCY SWITCHES



EMERGENCY SWITCHES







Used on: **Schaltbau**

S134 Single-pole		Current A	Max voltage V	Max length - front side - lateral side	Total height - in OFF pos - in ON pos	Remark	REF of complete switch	REF button
		250		70 mm 42 mm	126 mm 139 mm	2 connections.	165TA8443	
		250		70 mm 42 mm	132 mm 145 mm	2 connections.	165TA8449	
		250		70 mm 42 mm	177 mm 189 mm	2 connections.	165TA3581	
		250		70 mm 55 mm	95 mm 107 mm	2 connections.	165TA8444	
		250		70 mm 63 mm	132 mm 145 mm	2 connections.	165TA8448	
		250		70 mm 87 mm	132 mm 145 mm	2 connections.	105TA4853	
		250		70 mm 97 mm	132 mm 145 mm	2 connections.	165TA3572	
		250		70 mm 97 mm	132 mm 145 mm	5 connections.	139TA2711	

EMERGENCY SWITCHES



EMERGENCY SWITCHES

Used on: Schaltbau							
Single-pole 	Current A	Max voltage V	Max length - front side - lateral side	Total height - in OFF pos - in ON pos	Remark	REF of complete switch	REF button
	60	36	73 mm 32 mm	77 mm 84 mm	2 connections.	165TA3575	165TA3750 
Single-pole 	Current A	Max voltage V	Max length - front side - lateral side	Total height - in OFF pos - in ON pos	Remark	REF of complete switch	REF button
	200	24	153 mm 83 mm	170 mm 177 mm	12 connections.	165TA3580	165TA3828 
Single-pole 	Current A	Max voltage V	Max length - front side - lateral side	Total height - in OFF pos - in ON pos	Remark	REF of complete switch	REF button
	200	24	153 mm 83 mm	170 mm 177 mm	12 connections.	165TA3539	165TA3828 
Single-pole 	Current A	Max voltage V	Max length - front side - lateral side	Total height - in OFF pos - in ON pos	Remark	REF of complete switch	REF button
	200	24	153 mm 84 mm	169 mm 176 mm	12 connections.	165TA3563	165TA3828 
Single-pole 	Current A	Max voltage V	Max length - front side - lateral side	Total height - in OFF pos - in ON pos	Remark	REF of complete switch	REF button
	250	80	126 mm 89 mm	154 mm 162 mm	9 connections.	165TA3562	139TA2561 

